

# **FLEXPO** HYDRAULIC COMPONENTS

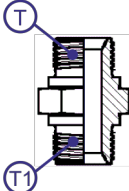
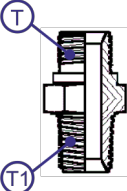
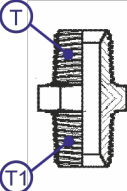

CATALOGO

**ADAPTERS BSP**  
Adapters BSP

FILETTO GAS/GAS CONICO		 <p>Niplo M/M Gas Cilindrico SV.60°</p>	 <p>Niplo M/M Gas Conico - Gas Cilindrico</p>	 <p>Niplo M/M Gas Conico - Conico</p>
Filetto T	Filetto T1	Codice	Codice	Codice
1/8"-28	1/8"-28	NGG02-02	NGC02-02	NCC02-02
1/4"-19	1/4"-19	NGG04-04	NGC04-04	NCC04-04
3/8"-19	3/8"-19	NGG06-06	NGC06-06	NCC06-06
1/2"-14	1/2"-14	NGG08-08	NGC08-08	NCC08-08
5/8"-14	5/8"-14	NGG10-10		
3/4"-14	3/4"-14	NGG12-12	NGC12-12	NCC12-12
1"-11	1"-11	NGG16-16	NGC16-16	NCC16-16
1.1/4"-11	1.1/4"-11	NGG20-20	NGC20-20	NCC20-20
1.1/2"-11	1.1/2"-11	NGG2424	NGC24-24	NCC24-24
2"-11	2"-11	NGG32-32	NGC32-32	NCC32-32
2.1/2"-11	2.1/2"-11	NGG40-40	NGC40-40	NCC40-40
3"-11	3"-11	NGG48-48	NGC48-48	

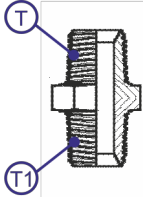
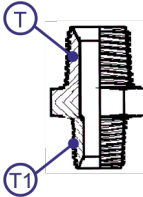
FILETTO NPTF		 Nipplo M/M NPTF SV.60°	 Nipplo M/M NPTF SV.60° Ridotto
Filetto T	Filetto T1	Codice	Codice
1/8"-27	1/8"-27	<b>NNN02-02</b>	
1/4"-18	1/8"-27		<b>NNN04-02</b>
1/4"-18	1/4"-18	<b>NNN04-04</b>	
3/8"-18	1/4"-18		<b>NNN06-04</b>
3/8"-18	3/8"-18	<b>NNN06-06</b>	
1/2"-14	1/4"-18		<b>NNN08-04</b>
1/2"-14	3/8"-18		<b>NNN08-06</b>
1/2"-14	1/2"-14	<b>NNN08-08</b>	
3/4"-14	1/4"-18		<b>NNN12-04</b>
3/4"-14	1/2"-14		<b>NNN12-08</b>
3/4"-14	3/4"-14	<b>NNN12-12</b>	
1"-11.1/2"	3/4"-14		<b>NNN16-12</b>
1"-11.1/2"	1"-11.1/2"	<b>NNN16-16</b>	
1.1/4"-11.1/2"	1"-11.1/2"		<b>NNN20-16</b>
1.1/4"-11.1/2"	1.1/4"-11.1/2"	<b>NNN20-20</b>	
1.1/2"-11.1/2"	1"-11.1/2"		<b>NNN24-16</b>
1.1/2"-11.1/2"	1.1/2"-11.1/2"	<b>NNN24-24</b>	

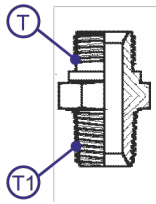
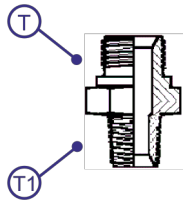
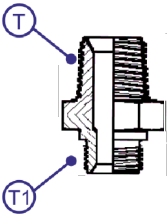
FILETTO GAS/NPTF		 Nipplo M/M NPTF-GAS Cilindrico	 Nipplo M/M NPTF-GAS Cilindrico Ridotto	 Nipplo M/M NPTF-GAS Cilindrico Ridotto
Filetto T	Filetto T1	Codice	Codice	Codice
1/8"-28	1/8"-27	<b>NGN02-02</b>		
1/4"-19	1/8"-27		<b>NGN04-02</b>	
1/4"-19	1/4"-18	<b>NGN04-04</b>		
1/4"-19	3/8"-18			<b>NGN04-06</b>
1/4"	1/2"			<b>NGN04-08</b>
3/8"-19	1/4"-18		<b>NGN06-04</b>	
3/8"-19	3/8"-18	<b>NGN06-06</b>		
3/8"-19	1/2"-14			<b>NGN06-08</b>
1/2"-14	3/8"-18		<b>NGN08-06</b>	
1/2"-14	1/2"-14	<b>NGN08-08</b>		
1/2"-14	3/4"-14			<b>NGN08-12</b>
1/2"-14	1"			<b>NGN08-16</b>
3/4"-14	1/2"-14		<b>NGN12-08</b>	
3/4"-14	3/4"-14	<b>NGN12-12</b>		
3/4"	1"			<b>NGN12-16</b>
1"-11	3/4"-14		<b>NGN16-12</b>	
1"-11	1"-11.1/2	<b>NGN16-16</b>		
1.1/4"	1"		<b>NGN20-16</b>	
1.1/4"-11	1.1/4"-11.1/2	<b>NGN20-20</b>		
1.1/2"-11	1.1/2"-11.1/2	<b>NGN24-24</b>		
2"-11	1.1/2"-11.1/2		<b>NGN-32-24</b>	
2"-11	2"-11.1/2	<b>NGN32-32</b>		
2.1/2"-11	2.1/2"-11.1/2	<b>NGN40-40</b>		

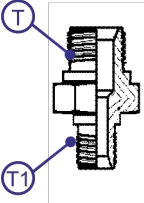
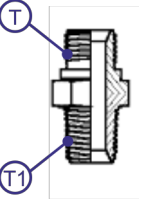
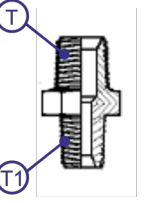
FILETTO GAS/GAS CONICO		 <p>Riduzione M/M GAS Cilindrico Sv.60°</p>	 <p>Riduzione M/M GAS-GAS Conico</p>	 <p>Riduzione M/M GAS-GAS Conico</p>
Filetto T	Filetto T1	Codice	Codice	Codice
1/8"-28	1/4"-19			NGC02-04
1/4"-19	1/8"-28	NGG04-02	NGC04-02	
1/4"-19	3/8"-19			NGC04-06
1/4"-19	1/2"-14			NGC04-08
3/8"-19	1/8"-28	NGG06-02		
3/8"-19	1/4"-19	NGG06-04	NGC06-04	
3/8"-19	1/2"-14			NGC06-08
1/2"-14	1/4"-19	NGG08-04	NGC08-04	
1/2"-14	3/8"-19	NGG08-06	NGC08-06	
1/2"-14	3/4"-14			NGC08-12
5/8"-14	1/4"-19	NGG10-04		
5/8"-14	3/8"-19	NGG10-06		
5/8"-14	1/2"-14	NGG10-08	NGC10-08	
3/4"-14	1/4"-19	NGG12-04		
3/4"-14	3/8"-19	NGG12-06		
3/4"-14	1/2"-14	NGG12-08	NGC12-08	
3/4"-14	5/8"-14	NGG12-10		
3/4"-14	1"-11			NGC12-16
1"-11	3/8"-19	NGG16-04		
1"-11	3/8"-19	NGG16-06		
1"-11	1/2"-14	NGG16-08		
1"-11	5/8"-14	NGG16-10		
1"-11	3/4"-14	NGG16-12	NGC16-12	
1"-11	1.1/4"-11			NGC16-20
1.1/4"-11	1/2"-14	NGG20-08		
1.1/4"-11	5/8"-14	NGG20-10		
1.1/4"-11	3/4"-14	NGG20-12		
1.1/4"-11	1"-11	NGG20-16	NGC20-16	
1.1/4"-11	1.1/2"-11			NGC20-24
1.1/2"-11	3/4"-14	NGG24-12		
1.1/2"-11	1"-11	NGG24-16		
1.1/2"-11	1.1/4"-11	NGG24-20	NGC24-20	
2"-11	1"-11	NGG32-16		
2"-11	1.1/4"-11	NGG32-20		
2"-11	1.1/2"-11	NGG32-24	NGC32-24	
2.1/2	1.1/2"	NGG40-24		
2.1/2	2"	NGG40-32		
3	2.1/2	NGG48-40		

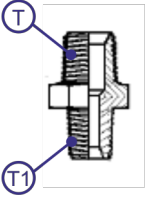
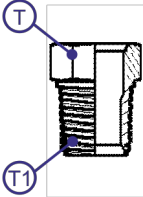
FILETTO GAS		 <p>Riduzione M/M GAS Conico-GAS Conico</p>	 <p>Riduzione Bassa F/M GAS Cil./Conico Sv. 60°</p>
Filetto T	Filetto T1	Codice	Codice
1/8"-28	1/4"-19		<b>CFMC02-04</b>
1/8"-28	3/8"-19		<b>CFMC02-06</b>
1/4"-19	1/8"-28	<b>NCC04-02</b>	
1/4"-19	3/8"-19		<b>CFMC04-06</b>
1/4"-19	1/2"-19		<b>CFMC04-08</b>
1/4"-19	3/4"-14		<b>CFMC04-12</b>
3/8"-19	1/4"-19	<b>NCC06-04</b>	
3/8"-19	1/2"-14		<b>CFMC06-08</b>
3/8"-19	3/4"-14	<b>NCC08-04</b>	<b>CFMC06-12</b>
1/2"-14	3/8"-19	<b>NCC08-06</b>	
1/2"-14	3/4"-14		<b>CFMC08-12</b>
1/2"-14	1"-11		<b>CFMC08-16</b>
3/4"-14	3/8"-19	<b>NCC12-08</b>	
3/4"-14	1"-11		<b>CFMC12-16</b>
3/4"-14	1.1/4"-11		<b>CFMC12-20</b>
1"-11	3/4"-14	<b>NCC16-12</b>	
1"-11	1.1/4"-11		<b>CFMC16-20</b>
1"-11	1.1/2"-11		<b>CFMC16-24</b>
1"-11	2"-11		<b>CFMC16-32</b>
1.1/4"-11	1"-11	<b>NCC20-16</b>	
1.1/4"-11	1.1/2"-11		<b>CFMC20-24</b>
1.1/4"-11	2"-11		<b>CFMC20-32</b>
1.1/2"-11	1.1/4"-11	<b>NCC24-20</b>	
1.1/2"-11	2"-11		<b>CFMC24-32</b>
1.1/2"-11	2.1/2		<b>CFMC24-40</b>
2"-11	1.1/2"	<b>NCC32-24</b>	

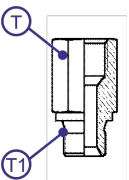
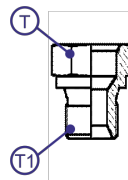
FILETTO GAS		 Riduzione Alta F/M Gas Cilindrico Sv.60°	 Riduzione Bassa F/M Gas Cilindrico Sv.60°
Filetto T	Filetto T1	Codice	Codice
1/8"-28	1/4"-19	CFM02-04	CFMB02-04
1/8"-28	3/8"-19	CFM02-06	CFMB02-06
1/4"-19	1/8"-28	CFM04-02	
1/4"-19	3/8"-19	CFM04-06	CFMB04-06
1/4"-19	1/2"-19	CFM04-08	CFMB04-08
1/4"-19	3/4"-14		CFMB04-12
1/4"-19	1"-11		CFMB04-16
3/8"-19	1/8"-28	CFM06-02	
3/8"-19	1/4"-19	CFM06-04	
3/8"-19	1/2"-14	CFM06-08	CFMB06-08
3/8"-19	3/4"-14	CFM06-12	CFMB06-12
3/8"-19	1"-11		CFMB06-16
1/2"-14	1/4"-19	CFM08-04	
1/2"-14	3/8"-19	CFM08-06	
1/2"-14	3/4"-14	CFM08-12	CFMB08-12
1/2"-14	1"-11	CFM08-16	CFMB08-16
1/2"-14	1.1/4"-11	CFM08-20	CFMB08-20
3/4"-14	1/4"-19	CFM12-04	
3/4"-14	3/8"-19	CFM12-06	
3/4"-14	1/2"-14	CFM12-08	
3/4"-14	1"-11	CFM12-16	CFMB12-16
3/4"-14	1.1/4"-11	CFM12-20	CFMB12-20
3/4"-14	1.1/2"-11		CFMB12-24
1"-11	3/8"-19	CFM16-06	
1"-11	1/2"-14	CFM16-08	
1"-11	3/4"-14	CFM16-12	
1"-11	1.1/4"-11	CFM16-20	CFMB16-20
1"-11	1.1/2"-11	CFM16-24	CFMB16-24
1.1/4"-11	1/2"-14	CFM20-08	
1.1/4"-11	3/4"-14	CFM20-12	
1.1/4"-11	1"-11	CFM20-16	
1.1/4"-11	1.1/2"-11	CFM20-24	CFMB20-24
1.1/4"-11	2"-11		CFMB20-32
1.1/2"-11	3/4"-14	CFM24-12	
1.1/2"-11	1"-11	CFM24-16	
1.1/2"-11	1.1/4"-11	CFM24-20	
1.1/2"-11	2"-11		CFMB24-32
2"-11	1.1/4"-11	CFM32-20	
2"-11	1.1/2"-11	CFM32-24	

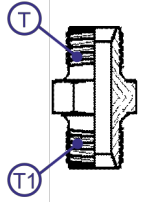
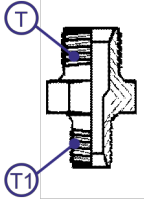
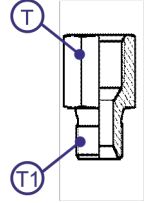
FILETTATURA METRICA		 Niplo M/M Metrico Sv.60°	 Riduzione M/M Metrico Sv.60°	 Riduzione F/M Metrico Sv.60°
Filetto T	Filetto T1	Codice	Codice	Codice
M10X1	M10X1	<b>NMM10C-10C</b>		
M12X1,5	M10X1		<b>NMM12A-10C</b>	
M12X1,25	M12X1,25	<b>NMM12A-12A</b>		
M14X1,4	M12X1,5		<b>NMM14A-12A</b>	
M14X1,4	M14X1,5	<b>NMM14A-14A</b>		
M16X1,5	M12X1,5		<b>NMM16A-12A</b>	
M16X1,5	M14X1,5		<b>NMM16A-14A</b>	
M16X1,5	M16X1,5	<b>NMM16A-16A</b>		
M18X1,5	M14X1,5		<b>NMM18A-14A</b>	
M18X1,5	M16X1,5		<b>NMM18A-16A</b>	
M18X1,5	M18X1,5	<b>NMM18A-18A</b>		
M18X1,5	M22X1,5			<b>CFM18A-22A</b>
M20X1,5	M16X1,5		<b>NMM20A-16A</b>	
M20X1,5	M18X1,5		<b>NMM20A-18A</b>	
M20X1,5	M20X1,5	<b>NMM20A-20A</b>		
M22X1,5	M18X1,5		<b>NMM22A-18A</b>	
M22X1,5	M20X1,5		<b>NMM22A-20A</b>	
M22X1,5	M22X1,5	<b>NMM22A-22A</b>		
M24X1,5	M18X1,5		<b>NMM24A-18A</b>	
M24X1,5	M22X1,5		<b>NMM24A-22A</b>	
M24X1,5	M24X1,5	<b>NMM24A-24A</b>		
M26X1,5	M18X1,5		<b>NMM26A-18A</b>	
M26X1,5	M22X1,5		<b>NMM26A-22A</b>	
M26X1,5	M26X1,5	<b>NMM26A-26A</b>		
M30X1,5	M26X1,5		<b>NMM30A-26A</b>	
M30X1,5	M30X1,5	<b>NMM30A-30A</b>		

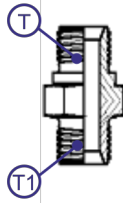
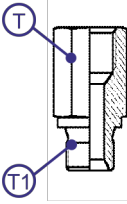
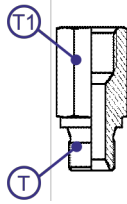

FILETTO GAS/ METRICO		 Riduzione M/M GAS/Metrico Cilindrico	 Riduzione F/M GAS/Metrico Cilindrico	 Riduzione F/M Metrico/GAS Cilindrico
Filetto T	Filetto T1	Codice	Codice	Codice
1/8"-28	M10X1	NGM02-12C		
1/4"-19	M10X1	NGM04-10C		CFM10C-04
1/4"-19	M12X1,5	NGM04-12A		
1/4"-19	M14X1,5	NGM04-14A	CFM04-14A	CFM14A-04
1/4"-19	M16X1,5	NGM04-16A	CFM04-16A	
1/4"-19	M18X1,5	NGM04-18A	CFM04-18A	
1/4"-19	M22X1,5	NGM04-22A		
3/8"-18	M10X1	NGM06-10C		
3/8"-18	M12X1,5	NGM06-12A		
3/8"-18	M14X1,5	NGM06-14A	CFM06-14A	CFM14A-06
3/8"-18	M16X1,5	NGM06-16A	CFM06-16A	CFM16A-06
3/8"-18	M18X1,5	NGM06-18A	CFM06-18A	CFM18A-06
3/8"-18	M20X1,5	NGM06-20A		
3/8"-18	M22X,15	NGM06-22A	CFM06-22A	
1/2"-14	M14X1,5	NGM08-14A		CFM14A-08
1/2"-14	M16X1,5	NGM08-16A		CFM16A-08
1/2"-14	M18X1,5	NGM08-18A	CFM08-18A	CFM18A-08
1/2"-14	M20X1,5	NGM08-20A		
1/2"-14	M22X,15	NGM08-22A	CFM08-22A	CFM22A-08
1/2"-14	M26X1,5	NGM08-26A		
5/8"-14	M22X1,5	NGM10-22A		
3/4"-14	M18X1	NGM12-18A		
3/4"-14	M20X1,5	NGM12-20A		
3/4"-14	M22X,15	NGM12-22A		
3/4"-14	M26X1,5	NGM12-26A		
3/4"-14	M30X1,5	NGM12-30A		
1"-11	M26X1,5	NGM16-26A		
1"-11	M30X1,5	NGM16-30A		

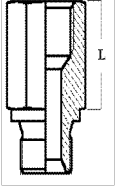
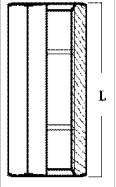
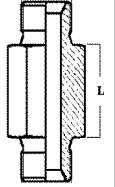
FILETTO GAS		 Prolunga M/F Gas	 Prolunga F/F Gas	 Prolunga M/M Gas
Filetto T	L. Esagono mm	Codice	Codice	Codice
1/8"-28	15	CMF02-15		
1/8"-28	21		CFF02-21	
1/8"-28	30	CMF02-30	CFF02-30	
1/8"-28	40	CMF02-40		
1/4"-19	15	CMF04-15		
1/4"-19	20	CMF04-20		
1/4"-19	22	CMF04-22		
1/4"-19	25	CMF04-25		
1/4"-19	28			CMM04-28
1/4"-19	30	CMF04-30	CFF04-30	
1/4"-19	36	CMF04-35	CFF04-35	
1/4"-19	40	CMF04-40		
1/4"-19	43	CMF04-45		
1/4"-19	48	CMF04-50		
3/8"-19	20	CMF06-20		
3/8"-19	22	CMF06-22		
3/8"-19	30	CMF06-30	CFF06-30	
3/8"-19	34			CMM06-35
3/8"-19	40	CMF06-40		
3/8"-19	42	CMF06-42		
3/8"-19	45	CMF06-45	CFF06-45	
3/8"-19	60	CMF06-60		
1/2"-14	20	CMF08-20		
1/2"-14	22	CMF08-22		
1/2"-14	25	CMF08-25		
1/2"-14	31	CMF08-30		
1/2"-14	40	CMF08-40	CFF08-40	CMM08-40
1/2"-14	45	CMF08-45	CFF08-45	
1/2"-14	65	CMF08-65		
5/8"-14	20	CMF10-20		
5/8"-14	45	CMF10-45		

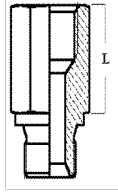
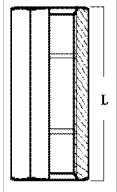
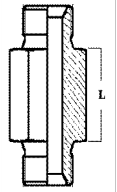
FILETTO GAS		 Prolunga M/F Gas	 Prolunga F/F Gas	 Prolunga M/M Gas
Filetto T	L. Esagono mm	Codice	Codice	Codice
3/4"-14	25	<b>CMF12-25</b>		
3/4"-14	32	<b>CMF12-30</b>		
3/4"-14	40		<b>CFF12-40</b>	<b>CMM12-40</b>
3/4"-14	45		<b>CFF12-45</b>	
3/4"-14	50	<b>CMF12-50</b>		
3/4"-14	60	<b>CMF12-60</b>		
1"	25	<b>CMF16-25</b>		
1"-11	30	<b>CMF16-30</b>		
1"-11	35	<b>CMF16-35</b>		
1"-11	42	<b>CMF16-40</b>		<b>CMM16-40</b>
1"-11	50		<b>CFF16-50</b>	
1"-11	55	<b>CMF16-55</b>		
1"-11	60	<b>CMF16-60</b>		
1"-11	65	<b>CMF16-65</b>		
1"-11	70	<b>CMF16-70</b>		
1.1/4"-11	30	<b>CMF20-30</b>		
1.1/4"-11	35	<b>CMF20-35</b>		
1.1/4"-11	40	<b>CMF20-40</b>		
1.1/4"-11	60		<b>CFF20-60</b>	
1.1/4"-11	67	<b>CMF20-67</b>		
1.1/4"-11	70	<b>CMF20-70</b>	<b>CFF24-70</b>	
1.1/2"-11	30	<b>CMF24-30</b>		
1.1/2"-11	35	<b>CMF24-35</b>		
1.1/2"-11	70			
1.1/2"-11	75	<b>CMF24-75</b>		
2"-11	35	<b>CMF32-35</b>		
2"-11	65		<b>CFF32-65</b>	
2"-11	80	<b>CMF32-80</b>	<b>CFF32-80</b>	
2.1/2"-11	35	<b>CMF40-35</b>		

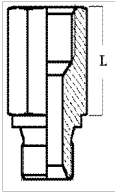
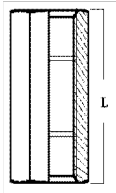
FILETTO METRICO		 Prolunga M/F Metrica	 Prolunga F/F Metrica
Filetto T	L. Esagono mm	Codice	Codice
M10X1	15	CMF10C-15	
M10X1	25		CFF10C-25
M10X1	29	CMF10C-30	
M12X1,5	25		CFF12A-25
M14X,15	16	CMF14A-145	
M14X,15	20		
M14X,15	35	CMF14A-35	CFF14A-35
M14X,15	40		
M16X1,5	20	CMF16A-20	
M16X1,5	35		CFF16A-35
M16X1,5	40	CMF16A-40	
M18X1,5	20	CMF18A-20	
M18X1,5	40	CMF18A-40	
M18X1,5	45		CFF18A-45
M20X1,5	20	CMF20A-20	
M22X1,5	45	CMF20A-45	
M22X1,5	20	CMF22A-20	
M22X1,5	45	CMF22A-45	CFF22A-45
M24X1,5	25		
M24X1,5	45		
M26X1,5	25	CMF26A-25	

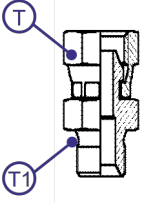
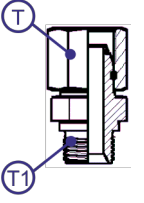
FILETTO GAS		 <p>Adattatore M/F Girevole Gas Cilindrico Sv. 60° Dado Pressato</p>	 <p>Adattatore M/F Girevole Gas Cilindrico Sv.60° Dado Spinato</p>
Filetto T1	Filetto T	Codice	Codice
1/8"-28	1/8"-28	MFG02-02	
1/4"-19	1/4"-19	MFG04-04	MFGDS04-04
1/4"-19	3/8"-19	MFG04-06	
3/8"-19	3/8"-19	MFG06-06	MFGDS06-06
3/8"-19	1/2"-14	MFG06-08	MFGDS06-08
1/2"-14	3/8"-19	MFG08-06	MFGDS08-06
1/2"-14	1/2"-14	MFG08-08	MFGDS08-08
1/2"-14	3/4"-14	MFG08-12	MFGDS08-12
5/8"-14	5/8"-14	MFG10-10	MFGDS10-10
3/4"-14	3/4"-14	MFG12-12	MFGDS12-12
3/4"-14	1"-11	MFG12-16	MFGDS12-16
1"-11	3/4"-14	MFG16-12	MFGDS16-12
1"-11	1"-11	MFG16-16	MFGDS16-16
1.1/4"-11	1.1/4"-11	MFG20-20	MFGDS20-20
1.1/2"-11	1.1/2"-11	MFG24-24	MFGDS24-24
2"-11	2"-11	MFG32-32	MFGDS32-32

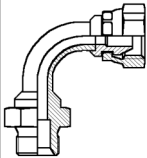
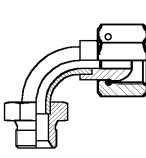
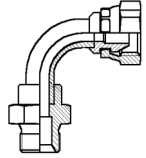
FILETTO GAS		 <p>Adatt. 90° M/F Gir. Gas Cil. Sv. 60° Pezzo Unico</p>	 <p>Adatt. 90° M/F Gir. Gas Cil. Sv. 60° Dado Spinato</p>	 <p>Adatt. 90° M/F Gir. Gas Cil. Sv.60° Saldato</p>
Filetto T1	Filetto T	Codice	Codice	Codice
1/8"-28	1/8"-28	90MFG02-02		90MFG02-02S
1/4"-19	1/4"-19	90MFG04-04	90MFGDS04-04	90MFG04-04S
1/4"-19	3/8"-19	90MFG04-06		
3/8"-19	3/8"-19	90MFG06-06	90MFGDS06-06	90MFG06-06S
3/8"-19	1/2"-14	90MFG06-08		
1/2"-14	3/8"-19	90MFG08-06		
1/2"-14	1/2"-14	90MFG08-08	90MFGDS08-08	90MFG08-08S
1/2"-14	3/4"-14	90MFG08-12		
5/8"-14	5/8"-14	90MFG10-10		90MFG10-10S
3/4"-14	3/4"-14	90MFG12-12	90MFGDS12-12	90MFG12-12S
3/4"-14	1"-11	90MFG12-16	90MFGDS12-16	
1"-11	3/4"-14	90MFG16-12	90MFGDS16-12	
1"-11	1"-11	90MFG16-16	90MFGDS16-16	90MFG16-16S
1.1/4"-11	1.1/4"-11	90MFG20-20	90MFGDS20-20	90MFG20-20S
1.1/2"-11	1.1/2"-11	90MFG24-24	90MFGDS24-24	90MFG24-24S
2"-11	2"-11	90MFG32-32	90MFGDS32-32	90MFG32-32S

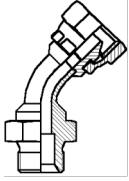
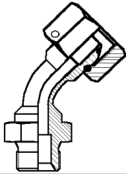
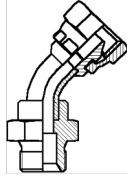
FILETTO GAS		 <p>Adatt. 45° M/F Gir. Gas Cil. Sv. 60° Pezzo Unico</p>	 <p>Adatt. 45° M/F Gir. Gas Cil. Sv. 60° Dado Spinato</p>	 <p>Adatt. 45° M/F Gir. Gas Cil. Sv. 60° Saldato</p>
Filetto T1	Filetto T	Codice	Codice	Codice
1/8"-28	1/8"-28			
1/4"-19	1/4"-19	<b>45MFG04-04</b>	<b>45MFGDS04-04</b>	<b>45MFG04-04S</b>
1/4"-19	3/8"-19			
3/8"-19	3/8"-19	<b>45MFG06-06</b>	<b>45MFGDS06-06</b>	<b>45MFG06-06S</b>
3/8"-19	1/2"-14			
1/2"-14	3/8"-19			
1/2"-14	1/2"-14	<b>45MFG08-08</b>	<b>45MFGDS08-08</b>	<b>45MFG08-08S</b>
1/2"-14	3/4"-14	<b>45MFG08-12</b>		
5/8"-14	5/8"-14			<b>45MFG10-10S</b>
3/4"-14	3/4"-14	<b>45MFG12-12</b>	<b>45MFGDS12-12</b>	<b>45MFG12-12S</b>
1"-11	1"-11	<b>45MFG16-16</b>	<b>45MFGDS16-16</b>	<b>45MFG16-16S</b>
1.1/4"-11	1.1/4"-11		<b>45MFGDS20-20</b>	<b>45MFG20-20S</b>
1.1/2"-11	1.1/2"-11		<b>45MFGDS24-24</b>	<b>45MFG24-24S</b>
2"-11	2"-11		<b>45MFGDS32-32</b>	<b>45MFG32-32S</b>

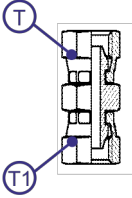
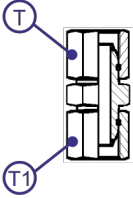
FILETTO GAS		 <p>Adattatore F/F Girevole Gas Cilindrico Sv. 60°</p>	 <p>Adattatore F/F Girevole Gas Cilindrico Sv.60° Saldato</p>
Filetto T1	Filetto T	Codice	Codice
1/4"-19	1/4"-19	<b>FFG04-04</b>	<b>FFGDS04-04</b>
3/8"-19	3/8"-19	<b>FFG06-06</b>	<b>FFGDS06-06</b>
1/2"-14	1/2"-14	<b>FFG08-08</b>	<b>FFGDS08-08</b>
5/8"-14	5/8"-14	<b>FFG10-10</b>	<b>FFGDS10-10</b>
3/4"-14	3/4"-14	<b>FFG12-12</b>	<b>FFGDS12-12</b>
1"-11	1"-11	<b>FFG16-16</b>	<b>FFGDS16-16</b>
1.1/4"-11	1.1/4"-11	<b>FFG20-20</b>	<b>FFGDS20-20</b>
1.1/2"-11	1.1/2"-11	<b>FFG24-24</b>	<b>FFGDS24-24</b>
2"-11	2"-11	<b>FFG32-32</b>	<b>FFGDS32-32</b>

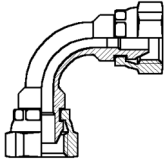
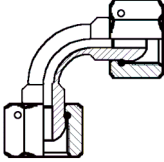
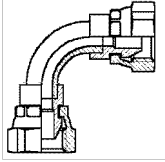

FILETTO GAS		 <p>Adatt. 90° F/F Gir. Gas Cil. Sv. 60° Intero</p>	 <p>Adatt. 90° F/F Gir. Gas Cil. Sv. 60° Dado Spinato</p>	 <p>Adatt. 90° F/F Gir. Gas Cil. Sv. 60° Saldato</p>
Filetto T1	Filetto T	Codice	Codice	Codice
1/8"-28	1/8"-28	90FFG02-02		90FFG02-02S
1/4"-19	1/4"-19	90FFG04-04	90FFGDS04-04	90FFG04-04S
3/8"-19	3/8"-19	90FFG06-06	90FFGDS06-06	90FFG06-06S
1/2"-14	1/2"-14	90FFG08-08	90FFGDS08-08	90FFG08-08S
5/8"-14	5/8"-14	90FFG10-10		90FFG10-10S
3/4"-14	3/4"-14	90FFG12-12	90FFGDS12-12	90FFG12-12S
1"-11	1"-11	90FFG16-16	90FFGDS16-16	90FFG16-16S
1.1/4"-11	1.1/4"-11	90FFG20-20	90FFGDS20-20	90FFG20-20S
1.1/2"-11	1.1/2"-11	90FFG24-24	90FFGDS24-24	90FFG24-24S
2"-11	2"-11	90FFG32-32	90FFGDS32-32	90FFG32-32S

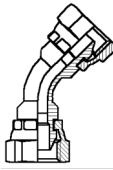
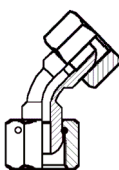
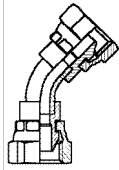

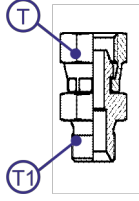
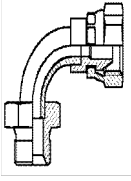
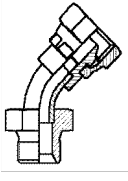
FILETTO GAS		 <p>Adattatore 90° F/F Girevole Gas Cilindrico Sv. 60° Intero</p>	 <p>Adattatore 90° F/F Girevole Gas Cilindrico Sv. 60° Dado Spinato</p>	 <p>Adattatore 90° F/F Girevole Gas Cilindrico Sv.60° Saldato</p>
Filetto T1	Filetto T	Codice	Codice	Codice
1/8"-28	1/8"-28	45FFG02-02		45FFGDS02-02S
1/4"-19	1/4"-19	45FFG04-04	45FFGDS04-04	45FFGDS04-04S
3/8"-19	3/8"-19	45FFG06-06	45FFGDS06-06	45FFGDS06-06S
1/2"-14	1/2"-14	45FFG08-08	45FFGDS08-08	45FFGDS08-08S
5/8"-14	5/8"-14	45FFG10-10		45FFGDS10-10S
3/4"-14	3/4"-14	45FFG12-12	45FFGDS12-12	45FFGDS12-12S
1"-11	1"-11	45FFG16-16	45FFGDS16-16	45FFGDS16-16S
1.1/4"-11	1.1/4"-11	45FFG20-20	45FFGDS20-20	45FFGDS20-20S
1.1/2"-11	1.1/2"-11	45FFG24-24	45FFGDS24-24	45FFGDS24-24S
2"-11	2"-11	45FFG32-32	45FFGDS32-32	45FFGDS32-32S

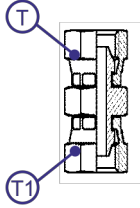
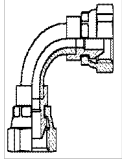
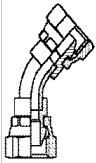
FILETTO METRICO		 <p>Adattatore M/F Gir. Metrico Cilindrico Sv. 60°</p>	 <p>Adattatore 90° M/F Gir. Metrico Cil. Sv. 60°</p>	 <p>Adattatore 45° M/F Gir. Gas Cil. Sv.60°</p>
Filetto T	Filetto T1	Codice	Codice	Codice
M12X1,5	M12X1,5		<b>90MFG12A-12A</b>	
M14X,15	M14X,15	<b>MFG14A-14A</b>	<b>90MFG14A-14A</b>	<b>45MFG14A-14A</b>
M16X1,5	M16X1,5	<b>MFG16A-16A</b>	<b>90MFG16A-16A</b>	<b>45MFG16A-16A</b>
M18X1,5	M18X1,5	<b>MFG18A-18A</b>	<b>90MFG18A-18A</b>	<b>45MFG18A-18A</b>
M20X1,5	M20X1,5	<b>MFG20A-20A</b>	<b>90MFG20A-20A</b>	<b>45MFG20A-20A</b>
M22X1,5	M22X1,5	<b>MFG22A-22A</b>	<b>90MFG22A-22A</b>	<b>45MFG22A-22A</b>
M26X1,5	M26X1,5	<b>MFG26A-26A</b>	<b>90MFG26A-26A</b>	<b>45MFG26A-26A</b>

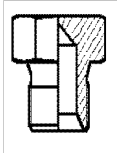
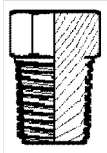
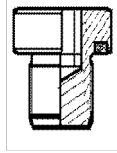
FILETTO METRICO		 <p>Adattatore F/F Gir. Metrico Cilindrico Sv. 60°</p>	 <p>Adattatore 90° F/F Gir. Metrico Cil. Sv. 60°</p>	 <p>Adattatore 45° F/F Gir. Metrico Cil. Sv.60°</p>
Filetto T	Filetto T1	Codice	Codice	Codice
M14X,15	M14X,15	<b>FFG14A-14A</b>	<b>90FFG14A-14A</b>	<b>45FFG14A-14A</b>
M16X1,5	M16X1,5	<b>FFG16A-16A</b>	<b>90FFG16A-16A</b>	<b>45FFG16A-16A</b>
M18X1,5	M18X1,5	<b>FFG18A-18A</b>	<b>90FFG18A-18A</b>	<b>45FFG18A-18A</b>
M20X1,5	M20X1,5	<b>FFG20A-20A</b>	<b>90FFG20A-20A</b>	<b>45FFG20A-20A</b>
M22X1,5	M22X1,5	<b>FFG22A-22A</b>	<b>90FFG22A-22A</b>	<b>45FFG22A-22A</b>
M26X1,5	M26X1,5	<b>FFG26A-26A</b>	<b>90FFG26A-26A</b>	<b>45FFG26A-26A</b>

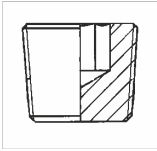
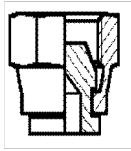
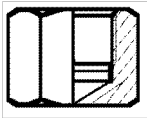
FILETTO GAS	 <p>Tappo Maschio Gas Cil. Svasato 60°</p>	 <p>Tappo Maschio Gas Conico</p>	 <p>Tappo Maschio Gas Esagono Incas. Guarn. Piana</p>
Filetto T	Codice	Codice	Codice
1/8"-28	TMS02		TMB02
1/4"-19	TMS04	TMC04	TMB04
3/8"-19	TMS06	TMC06	TMB06
1/2"-14	TMS08	TMC08	TMB08
5/8"-14	TMS10		
3/4"-14	TMS12	TMC12	TMB12
1"-11	TMS16	TMC16	TMB16
1.1/4"-11	TMS20		TMB20
1.1/2"-11	TMS24		TMB24
2"-11	TMS32		

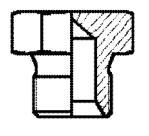
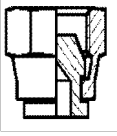
FILETTO GAS	 <p>Tappo a Grano Maschio Conico</p>	 <p>Tappo Femmina Girevole Gas Cilindrico Og 60°</p>	 <p>Tappo Femmina Fissa Gas Cilindrico</p>
Filetto T	Codice	Codice	Codice
1/8"-28	TGMC02	TFG02	TFF02
1/4"-19	TGMC04	TFG04	TFF04
3/8"-19	TGMC06	TFG06	TFF06
1/2"-14	TGMC08	TFG08	TFF08
5/8"-14		TFG10	TFF10
3/4"-14	TGMC12	TFG12	TFF12
1"-11	TGMC16	TFG16	TFF16
1.1/4"-11	TGMC20	TFG20	TFF20
1.1/2"-11	TGMC24	TFG24	TFF24
2"-11		TFG32	TFF32

FILETTO METRICO	 <p>Tappo Maschio Metrico Cil. Svasato 60°</p>	 <p>Tappo Femmina Girevole Metrico Cilindrico Og 60°</p>	 <p>Tappo Femmina Fissa Metrica Cilindrico</p>
Filetto T	Codice	Codice	Codice
M10X1	TMS10C		TFF10C
M12X1,5	TMS12A	TFG12A	TFF12A
M14X,15	TMS14A	TFG14A	TFF14A
M16X1,5	TMS16A	TFG16A	TFF16A
M18X1,5	TMS18A	TFG18A	TFF18A
M20X1,5	TMS20A	TFG20A	
M22X1,5	TMS22A	TFG22A	TFF22A
M24X1,5	TMS24A		
M26X1,5	TMS26A	TFG26A	TFF26A
M30X1,5	TMS30A		TFF30A

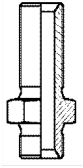
FILETTO GAS	 Passa parete Dritto Maschio Gas	Controdado Gas
Filetto T	Codice	Codice
1/4"-19	PPM04	CD 04
3/8"-19	PPM06	CD 06
1/2"-14	PPM08	CD 08
3/4"-14	PPM12	CD 12
1"-11	PPM16	CD 16
1.1/4"-11	PPM20	CD 20
1.1/2"-11	PPM24	CD 24

Per acquistare il passa parete completo aggiungere "C" alla fine del codice (es. codice: **PPM04-C**).

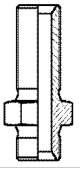
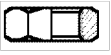

<p>FILETTO METRICO</p>	 <p>Passa parete Dritto Maschio Metrico Metric Bulkhead Connecting Nipple</p>	<p>Controdado Metrico Metric Lock Nut</p> 
<p>Filetto T</p>	<p>Codice</p>	<p>Codice</p>
<p>M14X,15</p>	<p><b>PPM14A</b></p>	<p><b>CD 14A</b></p>
<p>M18X1,5</p>	<p><b>PPM18A</b></p>	<p><b>CD 18A</b></p>

Per acquistare il passa parete completo aggiungere "C" alla fine del codice (es. codice: **PPM14A-C**).

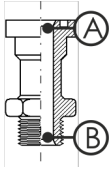
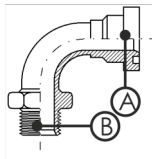
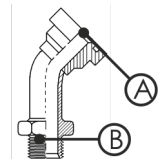
FLANGIA SAE J518 3000/MASCHIO GAS			Flangia Dritta SAE 3000/ Maschio Gas	Flangia 90° SAE 3000/ Maschio Gas	Flangia 45° SAE 3000/Maschio Gas
A		B			
Flangia	∅		Codice	Codice	Codice
1/2"	30,2	1/2"	<b>FLMG08-08</b>	<b>90FLMG08-08</b>	<b>45FLMG08-08</b>
3/4"	38,1	3/4"	<b>FLMG12-12</b>	<b>90FLMG12-12</b>	<b>45FLMG12-12</b>
1"	44,5	1"	<b>FLMG16-16</b>	<b>90FLMG16-16</b>	<b>45FLMG16-16</b>
1"	44,5	1.1/4"	<b>FLMG16-20</b>	<b>90FLMG16-20</b>	<b>45FLMG16-20</b>
1.1/4"	50,8	1"	<b>FLMG20-16</b>	<b>90FLMG20-16</b>	<b>45FLMG20-16</b>
1.1/4"	50,8	1.1/4"	<b>FLMG20-20</b>	<b>90FLMG20-20</b>	<b>45FLMG20-20</b>
1.1/2"	60,3	1.1/2"	<b>FLMG24-24</b>	<b>90FLMG24-24</b>	<b>45FLMG24-24</b>
2"	71,4	2"	<b>FLMG32-32</b>	<b>90FLMG32-32</b>	<b>45FLMG32-32</b>

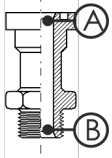
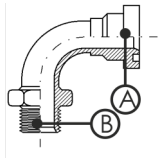
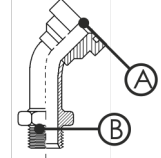
FLANGIA SAE J518 6000/MASCHIO GAS			Flangia Dritta SAE 3000/ Maschio Gas	Flangia 90° SAE 3000/ Maschio Gas	Flangia 45° SAE 3000/ Maschio Gas
A		B			
Flangia	∅		Codice	Codice	Codice
1/2"	31,5	1/2"	<b>FPMG08-08</b>	<b>90FPMG08-08</b>	<b>45FPMG08-08</b>
3/4"	41,3	3/4"	<b>FPMG12-12</b>	<b>90FPMG12-12</b>	<b>45FPMG12-12</b>
3/4"	41,3	1"	<b>FPMG12-16</b>	<b>90FPMG12-16</b>	<b>45FPMG12-16</b>
1"	47,6	1"	<b>FPMG16-16</b>	<b>90FPMG16-16</b>	<b>45FPMG16-16</b>
1"	47,6	1.1/4"	<b>FPMG16-20</b>	<b>90FPMG16-20</b>	<b>45FPMG16-20</b>
1.1/4"	54	1.1/4"	<b>FPMG20-20</b>	<b>90FPMG20-20</b>	<b>45FPMG20-20</b>
1.1/2"	63,5	1.1/4"	<b>FPMG24-20</b>	<b>90FPMG24-20</b>	<b>45FPMG24-20</b>
1.1/2"	63,5	1.1/2"	<b>FPMG24-24</b>	<b>90FPMG24-24</b>	<b>45FPMG24-24</b>
2"	79,4	1.1/4"	<b>FPMG32-24</b>	<b>90FPMG32-24</b>	<b>45FPMG32-24</b>
2"	79,4	2"	<b>FPMG32-32</b>	<b>90FPMG32-32</b>	<b>45FPMG32-32</b>

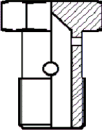
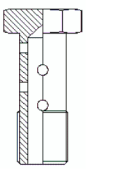
FILETTO GAS	 <p>Vite Forata Gas</p>	 <p>Vite Forata Doppia Gas</p>
Filetto T	Codice	Codice
1/8"-19	VF02	VFD02
1/4"-19	VF04	VFD04
3/8"-19	VF06	VFD06
1/2"-14	VF08	VFD08
5/8"-14	VF10	
3/4"-14	VF12	VFD12
1"-11	VF16	VFD16
1.1/4"-11	VF20	
1.1/2"-11	VF24	

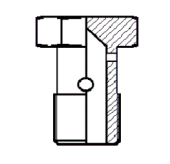
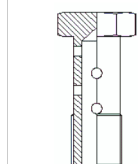
FILETTO METRICO	 <p>Vite Forata Gas</p>	 <p>Vite Forata Doppia Gas</p>
Filetto T	Codice	Codice
M6X1	VF06C	
M8X1	VF08C	VFD08C
M10X1	VF10C	VFD10C
M12X1,25	VF12D	
M12X1,5	VF12A	VFD12A
M14X,15	VF14A	VFD14A
M16X1,5	VF16A	VFD16A
M18X1,5	VF18A	VFD18A
M20X1,5	VF20A	VFD20A
M22X1,5	VF22A	VFD22A
M26X1,5	VF26A	
M30X1,5	VF30A	

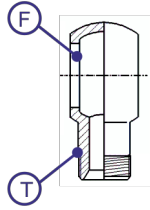
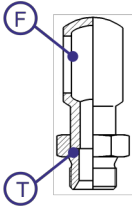
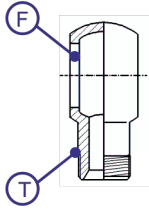
FILETTO GAS-METRICO		 Occhio Gas Filettatura Gas	 Occhio Gas Filettatura Gas Con Battuta	 Occhio Gas Filettatura Metrica
Occhio F	Filetto T	Codice	Codice	Codice
1/8"-19	1/8"-19	<b>OF02-02</b>		
1/4"-19	1/4"-19	<b>OF04-04</b>	<b>OFB04-04</b>	
1/4"-19	M14X1,5			<b>OF0414A</b>
3/8"-19	1/4"-19	<b>OF06-04</b>		
3/8"-19	3/8"-19	<b>OF06-06</b>	<b>OFB06-06</b>	
3/8"-19	M18X1,5			<b>OF0618A</b>
3/8"-19	1/2"-14	<b>OF06-08</b>		
1/2"-14	3/8"-19	<b>OF08-06</b>		
1/2"-14	1/2"-14	<b>OF08-08</b>	<b>OFB08-08</b>	
3/4"-14	1/2"-14	<b>OF12-08</b>		
3/4"-14	3/4"-14	<b>OF12-12</b>	<b>OFB12-12</b>	
1"-11	1"-11	<b>OF16-16</b>		

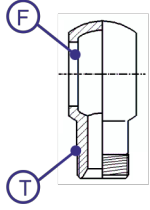
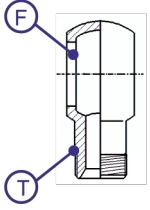
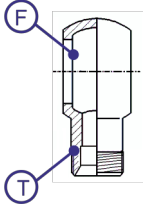

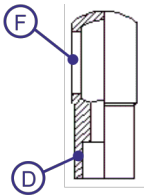
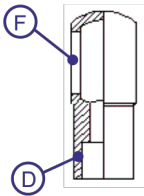
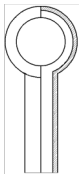
FILETTO METRICO-GAS		 Occhio Metrico Filettatura Metrica	 Occhio Metrico Filettatura Gas	 Occhio Gas Filettatura Din
Occhio F	Filetto T	Codice	Codice	Codice
M10X1	M10X1	<b>OF1010C</b>		
M14X,15	M14X,15	<b>OF1414A</b>		
M14X,15	1/4"-19		<b>OF1404</b>	
M16X1,5	M16X1,5	<b>OF1616A</b>		
M18X1,5	M18X1,5	<b>OF1818A</b>		
M18X1,5	3/8"-19		<b>OF1806</b>	
M18X1,5	1/2"-14		<b>OF1808</b>	
M22X1,5	M22X1,5	<b>OF2222A</b>		
1/4"	10L-M16X1,5			<b>OF0410L</b>
3/8"	12L-M18X1,5			<b>OF0612L</b>
3/8"	15L-M22X1,5			<b>OF0615L</b>
1/2"	12L-M18X1,5			<b>OF0812L</b>
1/2"	15L-M22X1,5			<b>OF0815L</b>

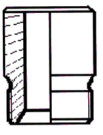
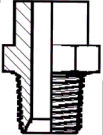

FILETTO GAS-METRICO			 <b>Occhio Gas a Saldare</b>	 <b>Occhio Metrico a Saldare</b>	 <b>Occhio Gas Codolo Lungo</b>
Occhio F	Tasca D		Codice	Codice	Codice
1/8"-19	6		<b>OST0206</b>		
1/4"-19	6		<b>OST0406</b>		
1/4"-19	8		<b>OST0408</b>		
1/4"-19	10		<b>OST0410</b>		
3/8"-19	10		<b>OST0610</b>		
3/8"-19	12		<b>OST0612</b>		
1/2"-14	15		<b>OST0815</b>		
1/2"-14	16		<b>OST0816</b>		
5/8"-14	18		<b>OST1018</b>		
3/4"-14	20		<b>OST1220</b>		
3/4"-14	22		<b>OST1222</b>		
1"-11	27		<b>OST1627</b>		
Occhio F	Tasca D				
M6X1	4			<b>OST0604</b>	
M8X1	5			<b>OST0805</b>	
M10X1	6			<b>OST1006</b>	
M12X1,5	8			<b>OST1208</b>	
M14X,15	10			<b>OST1410</b>	
M16X1,5	12			<b>OST1612</b>	
M18X1,5	12			<b>OST1812</b>	
M18X1,5	14			<b>OST0814</b>	
M18X1,5	15			<b>OST1815</b>	
M20X1,5	14			<b>OST2014</b>	
M22X1,5	16			<b>OST2216</b>	
M26X1,5	20			<b>OST2620</b>	
M26X1,5	22			<b>OST2622</b>	
Occhio F	ø Tubo	L. Tubo			
3/8"	12				<b>OGET0612-300</b>
3/8"	12				<b>OGET0612-400</b>

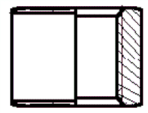
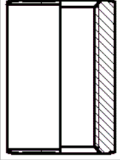

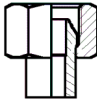
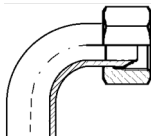
FILETTO GAS	 <p>Mezzo Nipplo a Saldare Gas</p>	 <p>Mezzo Nipplo Tondo a Saldare Gas</p>	 <p>Mezzo Nipplo a Saldare Gas Conico</p>
Filetto T T Thread	Codice	Codice	Codice
1/8"-28	NMS02		
1/4"-19	NMS04	NMTS04	NMCS04
3/8"-19	NMS06	NMTS06	NMCS06
1/2"-14	NMS08	NMTS08	NMCS08
5/8"-14	NMS10		NMCS10
3/4"-14	NMS12	NMTS12	NMCS12
1"-11	NMS16	NMTS16	NMCS16
1.1/4"-11	NMS20		NMCS20
1.1/2"-11	NMS24		NMCS24
2"-11	NMS32		NMCS32

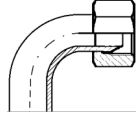
FILETTO GAS		 Borchia a Saldare Gas	 Manicotto a Saldare Gas
Filetto T	Filetto T1	Codice	Codice
1/8"-28	1/8"-28	<b>BFS02</b>	<b>MFS02</b>
1/4"-19	1/4"-19	<b>BFS04</b>	<b>MFS04</b>
3/8"-19	3/8"-19	<b>BFS06</b>	<b>MFS06</b>
1/2"-14	1/2"-14	<b>BFS08</b>	<b>MFS08</b>
5/8"-14	5/8"-14	<b>BFS10</b>	<b>MFS10</b>
3/4"-14	3/4"-14	<b>BFS12</b>	<b>MFS12</b>
1"-11	1"-11	<b>BFS16</b>	<b>MFS16</b>
1.1/4"-11	1.1/4"-11	<b>BFS20</b>	<b>MFS20</b>
1.1/2"-11	1.1/2"-11	<b>BFS24</b>	<b>MFS24</b>
2"-11	2"-11	<b>BFS32</b>	<b>MFS32</b>

FILETTO GAS	Ogiva Dado Libero a Saldare Gas 	Ogiva 90° Dado Libero a Saldare Gas 	Ogiva Dado Spinato a Saldare Gas 	Ogiva 90° Dado Spinato a Saldare Gas 
Filetto T T Thread	Codice	Codice	Codice	Codice
1/8"-28		90OSDL02	OSDP02	90OSDP02
1/4"-19	OSDL04	90OSDL04	OSDP04	90OSDP04
3/8"-19	OSDL06	90OSDL06	OSDP06	90OSDP06
1/2"-14	OSDL08	90OSDL08	OSDP08	90OSDP08
3/4"-14	OSDL12	90OSDL12	OSDP12	90OSDP12
1"-11	OSDL16	90OSDL16	OSDP16	90OSDP16
1.1/4"-11	OSDL20	90OSDL20	OSDP20	90OSDP20
1.1/2"-11	OSDL24	90OSDL24	OSDP24	90OSDP24
2"-11	OSDL32	90OSDL32	OSDP32	90OSDP32
2.1/2"-11	OSDL40			
3"-11	OSDL48			

FILETTO METRICO	Mezzo Niplo a Saldare Metrico  	Borchia a Saldare Metrica  
<b>Filetto T T Thread</b>	<b>Codice</b>	<b>Codice</b>
M10X1	<b>NMS10C</b>	<b>BFS10C</b>
M12X1,5	<b>NMS12A</b>	<b>BFS12A</b>
M14X,15	<b>NMS14A</b>	<b>BFS14A</b>
M16X1,5	<b>NMS16A</b>	<b>BFS16A</b>
M18X1,5	<b>NMS18A</b>	<b>BFS18A</b>
M20X1,5	<b>NMS20A</b>	<b>BFS20A</b>
M22X1,5	<b>NMS22A</b>	<b>BFS22A</b>
M26X1,5	<b>NMS26A</b>	
M30X1,5	<b>NMS30A</b>	

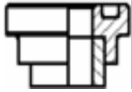
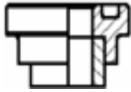
FLANGIA A SALDARE		Flangia a Saldare SAE 3000	Flangia a Saldare SAE 6000
			
Filetto T	Filetto T1	Codice	Codice
1/2"	16	<b>FLS08-16</b>	<b>FPS08-16</b>
3/4"	18	<b>FLS12-18</b>	<b>FPS12-18</b>
3/4"	20	<b>FLS12-20</b>	<b>FPS12-20</b>
1"	22	<b>FLS16-20</b>	<b>FPS16-20</b>
1"	26	<b>FLS16-25</b>	<b>FPS16-25</b>
1.1/4"	30	<b>FLS20-30</b>	
1.1/4"	32	<b>FLS20-32</b>	<b>FPS20-32</b>
1.1/2"	35	<b>FLS24-35</b>	<b>FPS24-35</b>
1.1/2"	38	<b>FLS24-38</b>	<b>FPS24-38</b>
2"	50	<b>FLS32-50</b>	<b>FPS32-50</b>

# ADATTATORI STAMPATI

Via T. Zaniboni, 29 – 46019 Viadana (MN) – Z. I. Gerbolina  
Tel. 0375-785148 Fax 0375-784323 – E-mail: [info@flexpo.it](mailto:info@flexpo.it) [www.flexpo.it](http://www.flexpo.it)  
Reg. Imp. Mantova/C.F./P.IVA 02181440203 - N°R.E.A. 231008 – Cap.Soc. 10.000,00 i.v.

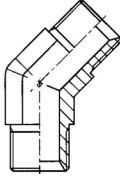
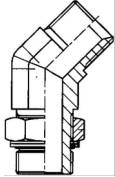
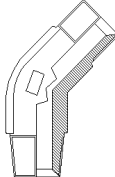
FILETTO GAS	 <p>Gomito 45° M/M Gas Sv.60°</p>	 <p>Gomito 45° M/M Gas Orientabile</p>	 <p>Gomito 45° M Gas Sv.60° M Gas Conico</p>
Filetto T T Thread	Codice	Codice	Codice
1/4"-19	<b>G45MM04</b>	<b>G45MMO04</b>	<b>G45MMC04</b>
3/8"-19	<b>G45MM06</b>	<b>G45MMO06</b>	<b>G45MMC06</b>
1/2"-14	<b>G45MM08</b>	<b>G45MMO08</b>	<b>G45MMC08</b>
3/4"-14	<b>G45MM12</b>	<b>G45MMO12</b>	<b>G45MMC12</b>
1"-11	<b>G45MM16</b>	<b>G45MMO16</b>	<b>G45MMC06</b>
1.1/4"-11	<b>G45MM20</b>		<b>G45MMC20</b>
1.1/2"-11	<b>G45MM24</b>		<b>G45MMC24</b>

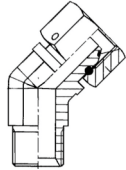
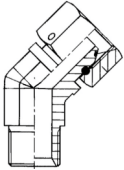
FILETTO GAS	 <p>Gomito 45° M Gas F Girevole Gas Sv.60°</p>	 <p>Gomito 45° M Gas Conico F Girevole Gas</p>
Filetto T T Thread	Codice	Codice
1/4"-19	G45MFG04	G45MCFG04
3/8"-19	G45MFG06	G45MCFG06
1/2"-14	G45MFG08	G45MCFG08
3/4"-14	G45MFG12	G45MCFG12
1"-11	G45MFG16	G45MCFG16
1.1/4"-11	G45MFG20	G45MCFG20
1.1/2"-11	G45MFG24	G45MCFG24

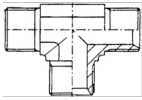
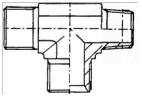
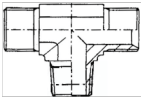

FILETTO GAS	 <p>Adattatore "T" M/M/M Gas Sv.60°</p>	 <p>Adattatore "T" M Gas/M Gas/ M Conico</p>	 <p>Adattatore "T" M Gas/M Conico/ M Gas</p>
Filetto T T Thread	Codice	Codice	Codice
1/8"-28	TMMM02	TMMMC02	TMMCM02
1/4"-19	TMMM04	TMMMC04	TMMCM04
3/8"-19	TMMM06	TMMMC06	TMMCM06
1/2"-14	TMMM08	TMMMC08	TMMCM08
5/8"-14			TMMCM10
3/4"-14	TMMM12	TMMMC12	TMMCM12
1"-11	TMMM16	TMMMC16	TMMCM16
1.1/4"-11	TMMM20	TMMMC20	TMMCM20
1.1/2"-11	TMMM24	TMMMC24	TMMCM24

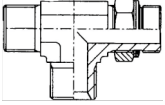
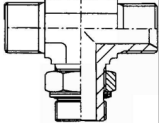
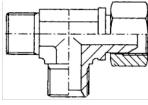
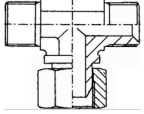
FILETTO GAS	Adattatore "T" M/M/M OR. Gas Sv.60°	Adattatore "T" M/M OR./ M Gas Sv.60°	Adattatore "T" M/M/F Gir. Gas Sv.60°	Adattatore "T" M/F Gir./M Gas Sv.60
Filetto T T Thread				
	<b>Codice</b>	<b>Codice</b>	<b>Codice</b>	<b>Codice</b>
	1/4"-19	TMMMO04	TMMOM04	TMMFG04
	3/8"-19	TMMMO06	TMMOM06	TMMFG06
	1/2"-14	TMMMO08	TMMOM08	TMMFG08
	3/4"-14	TMMMO12	TMMOM12	TMMFG12
	1"-11	TMMMO16	TMMOM16	TMMFG16
	1.1/4"-11	TMMMO20	TMMOM20	TMMFG20
	1.1/2"-11	TMMMO24	TMMOM24	TMMFG24

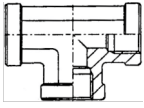
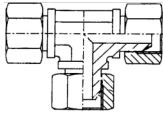
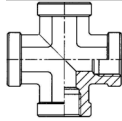
FILETTO GAS	Adattatore "T" F/F/F Fissa Gas 	Adattatore "T" F/F/F Gir. Gas Og.60° 	Adattatore a Croce F/F/F/F Gas 
Filetto T T Thread	Codice	Codice	Codice
1/8"-19	TFFF02		
1/4"-19	TFFF04	TFFFG04	CFFFF04
3/8"-19	TFFF06	TFFFG06	CFFFF06
1/2"-14	TFFF08	TFFFG08	CFFFF08
5/8"-14			CFFFF10
3/4"-14	TFFF12	TFFFG12	CFFFF12
1"-11	TFFF16	TFFFG16	CFFFF16
1.1/4"-11	TFFF20	TFFFG20	CFFFF20
1.1/2"-11	TFFF24	TFFFG24	CFFFF24
2"-11		TFFFG32	

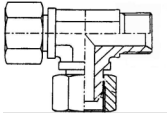
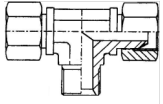
FILETTO GAS	Adattatore "T" F Gir./F Gir./M Sv.60° 	Adattatore a "T" F Gir./M/F Gir. 60° 
Filetto T T Thread	Codice	Codice
1/4"-19	TFGFGM04	TFGMFG04
3/8"-19	TFGFGM06	TFGMFG06
1/2"-14	TFGFGM08	TFGMFG08
3/4"-14	TFGFGM12	TFGMFG12
1"-11	TFGFGM16	TFGMFG16

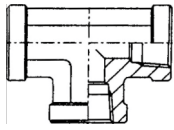
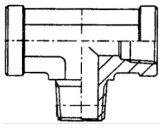
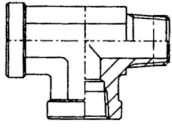
FILETTO NPT	Adattatore "T" F/F/F Fissa NPT	Adattatore "T" F/F/M NPT	Adattatore "T" F/F/M NPT
			
Filetto T T Thread	Codice	Codice	Codice
1/8"-27	TFFFN02	TFMFN02	TFFMN02
1/4"-18	TFFFN04	TFMFN04	TFFMN04
3/8"-18	TFFFN06	TFMFN06	TFFMN06
1/2"-14	TFFFN08	TFMFN08	TFFMN08
3/4"-14	TFFFN12	TFMFN12	TFFMN12
1"-11.1/2	TFFFN16	TFMFN16	TFFMN16
1.1/4"-11.1/2	TFFFN20	TFMFN20	TFFMN20
1.1/2"-11.1/2	TFFFN24	TFMFN24	TFFMN24

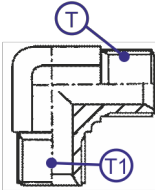
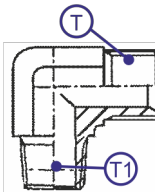
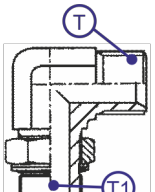
FILETTO GAS		 <p>Gomito 90° M/M Gas Sv. 60°</p>	 <p>Gomito 90° M Gas Sv.60° M Gas Conico</p>	 <p>Gomito 90° M/M Orientabile Gas SV. 60°</p>
Filetto T	Filetto T1	Codice	Codice	Codice
1/8"-28	1/8"-28	<b>G90MM02</b>	<b>G90MMC02</b>	<b>G90MMO02</b>
1/4"-19	1/8"-28			<b>G90MMO04-02</b>
1/4"-19	1/4"-19	<b>G90MM04</b>	<b>G90MMC04</b>	<b>G90MMO04-02</b>
3/8"-19	1/4"-19			<b>G90MMO06-04</b>
3/8"-19	3/8"-19	<b>G90MM06</b>	<b>G90MMC06</b>	<b>G90MMO06</b>
1/2"-14	3/8"-19			<b>G90MMO08-06</b>
1/2"-14	1/2"-14	<b>G90MM08</b>	<b>G90MMC08</b>	<b>G90MMO08</b>
3/4"-14	3/4"-14	<b>G90MM12</b>	<b>G90MMC12</b>	<b>G90MMO12</b>
1"-11	1"-11	<b>G90MM16</b>	<b>G90MMC16</b>	<b>G90MMO16</b>
1.1/4"-11	1.1/4"-11	<b>G90MM20</b>	<b>G90MMC20</b>	<b>G90MMO20</b>
1.1/2"-11	1.1/2"-11	<b>G90MM24</b>	<b>G90MMC24</b>	<b>G90MMO24</b>

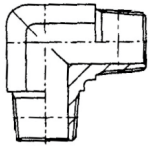
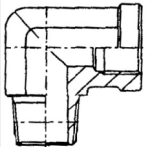
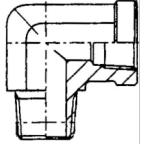
FILETTO GAS	 <p>Gomito 90° M/M Gas Conico</p>	 <p>Gomito 90° M Gas Conico F Fissa Gas</p>	 <p>Gomito 90° M NPT F Fissa NPT</p>
Filetto T T Thread	Codice	Codice	Codice
1/8"-28	G90MCMC02	G90MCF02	G90MFN02
1/4"-19	G90MCMC04	G90MCF04	G90MFN04
3/8"-19	G90MCMC06	G90MCF06	G90MFN06
1/2"-14	G90MCMC08	G90MCF08	G90MFN08
3/4"-14	G90MCMC12	G90MCF12	G90MFN12
1"-11	G90MCMC16	G90MCF16	G90MFN16
1.1/4"-11	G90MCMC20	G90MCF20	G90MFN20
1.1/2"-11	G90MCMC24	G90MCF24	G90MFN24

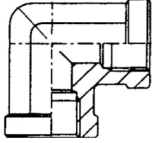
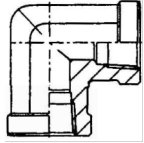
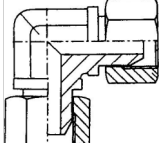
FILETTO GAS	 <p>Gomito 90° F/F Fissa Gas Cilindrico</p>	 <p>Gomito 90° F/F Fissa NPT</p>	 <p>Gomito 90° F/F Girevole Gas Cilindrico</p>
Filetto T T Thread	Codice	Codice	Codice
1/8"-28	G90FF02	G90FFN02	G90FFG02
1/4"-19	G90FF04	G90FFN04	G90FFG04
3/8"-19	G90FF06	G90FFN06	G90FFG06
1/2"-14	G90FF08	G90FFN08	G90FFG08
3/4"-14	G90FF12	G90FFN12	G90FFG12
1"-11	G90FF16	G90FFN16	G90FFG16
1.1/4"-11	G90FF20	G90FFN20	G90FFG20
1.1/2"-11	G90FF24	G90FFN24	G90FFG24

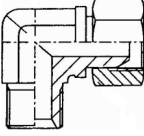
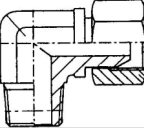
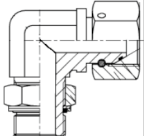

FILETTO GAS	 <p>Gomito 90° M/F Girevole Gas Sv.60°</p>	 <p>Gomito 90° M Gas Conico F Girevole Gas</p>	 <p>Gomito 90° M Orientabile F Girevole Gas Sv.60°</p>
Filetto T T Thread	Codice	Codice	Codice
1/4"-19	G90MFG04	G90MCFG04	G90MOFG04
3/8"-19	G90MFG06	G90MCFG06	G90MOFG06
1/2"-14	G90MFG08	G90MCFG08	G90MOFG08
3/4"-14	G90MFG12	G90MCFG12	G90MOFG12
1"-11	G90MFG16	G90MCFG16	G90MOFG16
1.1/4"-11	G90MFG20	G90MCFG20	G90MOFG20
1.1/2"-11	G90MFG24	G90MCFG24	G90MOFG24